

Extremely Low Profile Linear Motors, **LMSA** Series

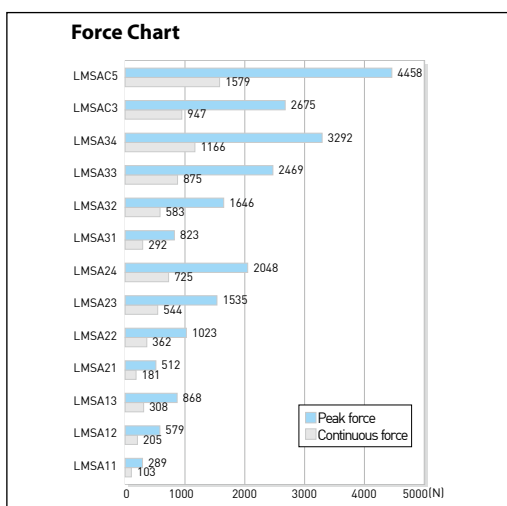

HIWIN synchronous low profile linear motors LMSA are the power packs of linear drives, and especially distinguished by very high power density and minimum cogging force. This three-phase motor is composed of a primary part (forcer) with coiled stack of sheets and a secondary part (stators) with permanent magnets. With the combination of several stators, many stroke combinations are possible.

- Low profile and compact size
- High dynamic response
- Low cogging force
- Moderate magnetic attraction preload
- Continuous force from 103N to 1579N
- Peak force from 289N to 4458N

Structure of the order number of linear motors LMSA, forcer

LM SA 1 1 L

Series

LM: linear motor

Type

SA: linear motor type

Width of forcer

- 1: 56mm
- 2: 86mm
- 3: 116mm
- C: 123.5mm

Length of forcer

- 1: 118 mm
- 2: 223 mm
- 3: 328 mm
- 4: 433 mm
- 5: 538 mm

Wiring code

- N: Standard
- L: Low back emf

Structure of the order number of linear motors LMSA, stator

LM SA 1 S 1 EA

Series

LM: linear motor

Type

SA: linear motor type

Width of stator

- 1: 52 mm
- 2: 86 mm
- 3: 116 mm
- C: 126 mm

Stator model

- S: Standard
- C: Customized

Length of stator

- 1: 120 mm
- 2: 180 mm
- 3: 300 mm

Cover for magnet

- EA: Epoxy covered
- None: Stainless plate

Mounting tolerance

LMSA1 □

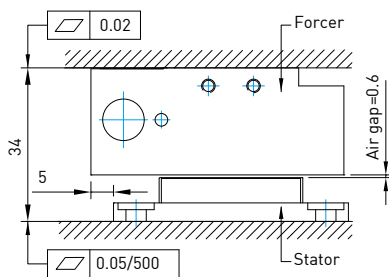

LMSA3 □

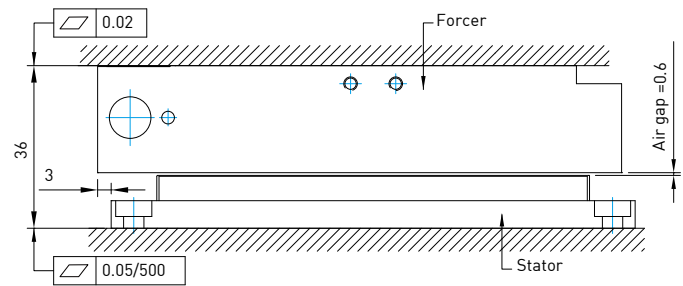

LMSA2 □

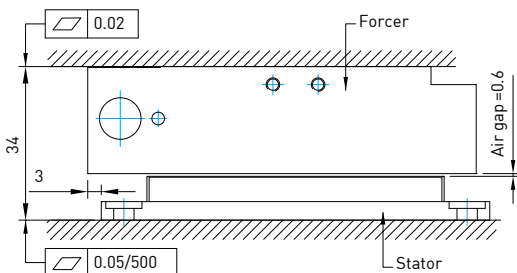

LMSAC □

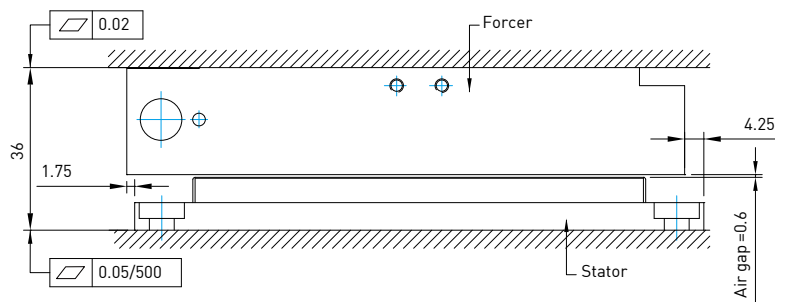

Specifications

	Symbol	Unit	LMSA11	LMSA11L	LMSA12	LMSA12L	LMSA13	LMSA13L	LMSA21	LMSA21L	LMSA22	LMSA22L	LMSA23	LMSA23L	LMSA24
Continuous force	F _c	N	103	103	205	205	308	308	181	181	362	362	544	544	725
Continuous current	I _c	A (rms)	2.1	4.7	4.2	9.4	6.3	14.1	2.0	4.4	3.9	8.8	5.9	13.1	7.8
Peak force (for 1 sec.)	F _p	N	289	289	579	579	868	868	512	512	1023	1023	1535	1535	2048
Peak current (for 1 sec.)	I _p	A (rms)	6.3	14.1	12.7	28.3	19.0	42.4	5.9	13.1	11.8	26.3	17.6	39.4	23.5
Ultimate force (for 0.25 sec.)	F _u	N	379	379	759	759	1138	1138	670	670	1341	1341	2011	2011	2682
Ultimate current (for 0.25 sec.)	I _u	A(rms)	10.6	23.6	21.1	47.1	31.7	70.7	9.8	21.9	19.6	43.8	29.4	65.7	39.2
Force constant	K _f	N/A (rms)	48.6	21.7	48.6	21.7	48.6	21.7	92.5	41.4	92.5	41.4	92.5	41.4	92.5
Attraction force	F _a	N	481	481	963	963	1444	1444	963	963	1926	1926	2888	2888	3851
Max. winding temp.	T _{max}	°C	120												
Electrical time constant	K _e	ms	4.4	4.3	4.5	4.1	4.4	4.0	4.6	4.6	4.9	4.6	4.9	4.8	4.6
Resistance (line to line at 25°C)	R ₂₅	Ω	8.4	1.7	4.1	0.9	2.8	0.6	13.8	2.8	6.8	1.4	4.6	0.9	3.5
Resistance (line to line at 120°C)	R ₁₂₀	Ω	11.6	2.3	5.7	1.2	3.9	0.8	19.0	3.9	9.4	1.9	6.3	1.2	4.8
Inductance (line to line)	L	mH	37.1	7.3	18.5	3.7	12.4	2.4	64.0	12.8	33.0	6.4	22.4	4.3	16.0
Pole pair pitch	2 τ	mm	30												
Minimum bending radius of cable	R _{bend}	mm	69												
Back emf constant (line to line)	K _v	Vrms/(m/s)	28.1	12.6	28.1	12.6	28.1	12.6	53.4	23.9	53.4	23.9	53.4	23.9	53.4
Motor constant (at 25°C)	K _m	N/√W	13.7	13.6	19.6	18.7	23.7	22.9	20.3	20.2	28.9	28.6	35.2	35.6	40.6
Thermal resistance	R _{TH}	°C/W	1.23	1.23	0.63	0.63	0.41	0.41	0.87	0.87	0.44	0.44	0.29	0.29	0.22
Thermal time constant	t _{TH}	s	1830	1830	2720	2720	4210	4210	2830	2830	4060	4060	5080	5080	-
Thermal switch	-	-	3 PTC SNM120 In Series												
Max. DC bus voltage	V _{DC}	V	600												
Mass of forcer	M _f	kg	0.7	0.7	1.4	1.4	2.1	2.1	1.1	1.1	2.2	2.2	3.3	3.3	4.4
Unit mass of stator	M _s	kg/m	2.7	2.7	2.7	2.7	2.7	2.7	4.8	4.8	4.8	4.8	4.8	4.8	4.8
Width of stator	W _s	mm	52	52	52	52	52	52	86	86	86	86	86	86	86
Length of stator/Dimension N	L _s	mm	120mm/N=2, 180mm/N=3, 300mm/N=5												
Stator mounting distance	W _{s1}	mm	42	42	42	42	42	42	74	74	74	74	74	74	74
Total height	H	mm	34	34	34	34	34	34	34	34	34	34	34	34	34

	Symbol	Unit	LMSA24L	LMSA31	LMSA31L	LMSA32	LMSA32L	LMSA33	LMSA33L	LMSA34	LMSA34L	LMSAC3	LMSAC3L	LMSAC5	LMSAC5L
Continuous force	F _c	N	725	292	292	583	583	875	875	1166	1166	947	947	1579	1579
Continuous current	I _c	A (rms)	17.5	2.0	4.5	4.0	8.9	6.0	13.4	8.0	17.9	6.0	13.4	10.0	22.3
Peak force (for 1 sec.)	F _p	N	2048	823	823	1646	1646	2469	2469	3292	3292	2675	2675	4458	4458
Peak current (for 1 sec.)	I _p	A (rms)	52.5	6.0	13.4	12.0	26.8	18.0	40.2	24.0	53.6	18.0	40.2	30.0	67.0
Ultimate force (for 0.25 sec.)	F _u	N	2682	1079	1079	2157	2157	3236	3236	4314	4314	3505	3505	5842	5842
Ultimate current (for 0.25 sec.)	I _u	A(rms)	87.6	10.0	22.3	20.0	44.7	30.0	67.0	40.0	89.4	30.0	67.0	50.0	111.7
Force constant	K _f	N/A (rms)	41.4	145.8	65.2	145.8	65.2	145.8	65.2	145.8	65.2	157.9	70.7	157.9	70.7
Attraction force	F _a	N	3851	1444	1444	2888	2888	4333	4333	5777	5777	4694	4694	7823	7823
Max. winding temp.	T _{max}	°C	120												
Electrical time constant	K _e	ms	4.7	4.9	4.9	4.9	4.9	4.9	5.0	4.9	4.9	5.0	5.0	5.0	5.0
Resistance (line to line at 25°C)	R ₂₅	Ω	0.7	19.2	4.0	9.6	2.0	6.4	1.3	4.8	1.0	6.8	1.4	4.1	0.8
Resistance (line to line at 120°C)	R ₁₂₀	Ω	0.9	26.5	5.5	13.2	2.8	8.8	1.8	6.6	1.3	9.4	1.9	5.7	1.1
Inductance (line to line)	L	mH	3.2	94.1	19.6	47.1	9.8	31.3	6.5	23.5	4.7	33.8	6.8	20.3	4.1
Pole pair pitch	2 τ	mm	30												
Minimum bending radius of cable	R _{bend}	mm	69												
Back emf constant (line to line)	K _v	Vrms/(m/s)	23.9	84.2	37.7	84.2	37.7	84.2	37.7	84.2	37.7	91.2	40.8	91.2	40.8
Motor constant (at 25°C)	K _m	N/√W	40.8	27.2	26.6	38.4	37.7	47.0	46.7	54.3	54.5	49.3	49.5	63.7	63.9
Thermal resistance	R _{TH}	°C/W	0.22	0.60	0.60	0.30	0.30	0.20	0.20	0.15	0.15	0.19	0.19	0.11	0.11
Thermal time constant	t _{TH}	s	-	4540	4540	5740	5740	5580	5580	-	-	-	-	-	-
Thermal switch	-	-	3 PTC SNM120 In Series												
Max. DC bus voltage	V _{DC}	V	600												
Mass of forcer	M _f	kg	4.4	1.9	1.9	3.8	3.8	5.7	5.7	7.6	7.6	6.3	6.3	10.5	10.5
Unit mass of stator	M _s	kg/m	4.8	8.5	8.5	8.5	8.5	8.5	8.5	8.5	8.5	9.7	9.7	9.7	9.7
Width of stator	W _s	mm	86	116	116	116	116	116	116	116	116	126	126	126	126
Length of stator/Dimension N	L _s	mm	120mm/N=2, 180mm/N=3, 300mm/N=5												
Stator mounting distance	W _{s1}	mm	74	104	104	104	104	104	104	104	104	114	114	114	114
Total height	H	mm	34	36	36	36	36	36	36	36	36	36	36	36	36

Note : Values in the table refer to operation without forced cooling.
 Except dimensions, all the electrical specifications in the table are in ±10% of tolerance.
 We keep the right to revise above content without prior notice.
 Specification is based on the final drawing confirmed by the customer.

Dimensions of Forcer

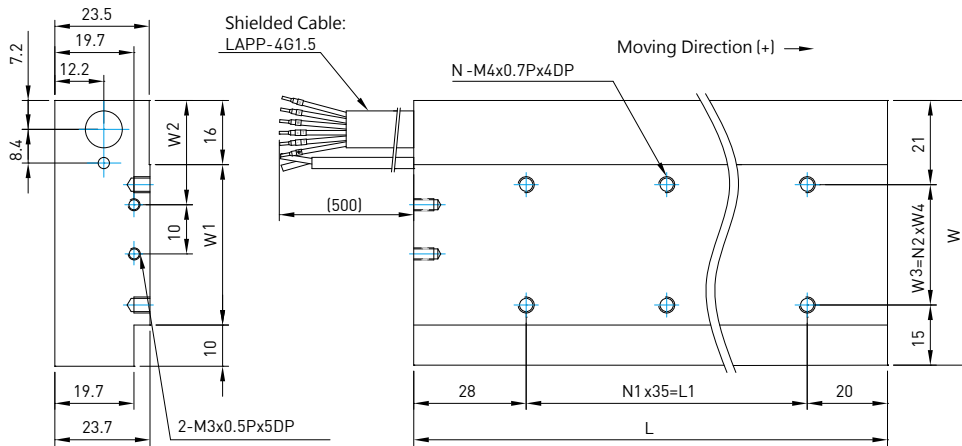

Type	L	L1	W	W1	W2	W3	W4	N	N1	N2
LMSA11	118	70	56	30	26	20	20	6	2	1
LMSA12	223	175	56	30	26	20	20	12	5	1
LMSA13	328	280	56	30	26	20	20	18	8	1
LMSA21	118	70	86	60	41	50	50	6	2	1
LMSA22	223	175	86	60	41	50	50	12	5	1
LMSA23	328	280	86	60	41	50	50	18	8	1
LMSA24	433	385	86	60	41	50	50	24	11	1
LMSA31	118	70	116	90	56	80	40	9	2	2
LMSA32	223	175	116	90	56	80	40	18	5	2
LMSA33	328	280	116	90	56	80	40	27	8	2
LMSA34	433	385	116	90	56	80	40	36	11	2
LMSAC3	328	280	123.5	97.5	59.75	80	40	27	8	2
LMSAC5	538	490	123.5	97.5	59.75	80	40	45	14	2

Dimensions of Stator

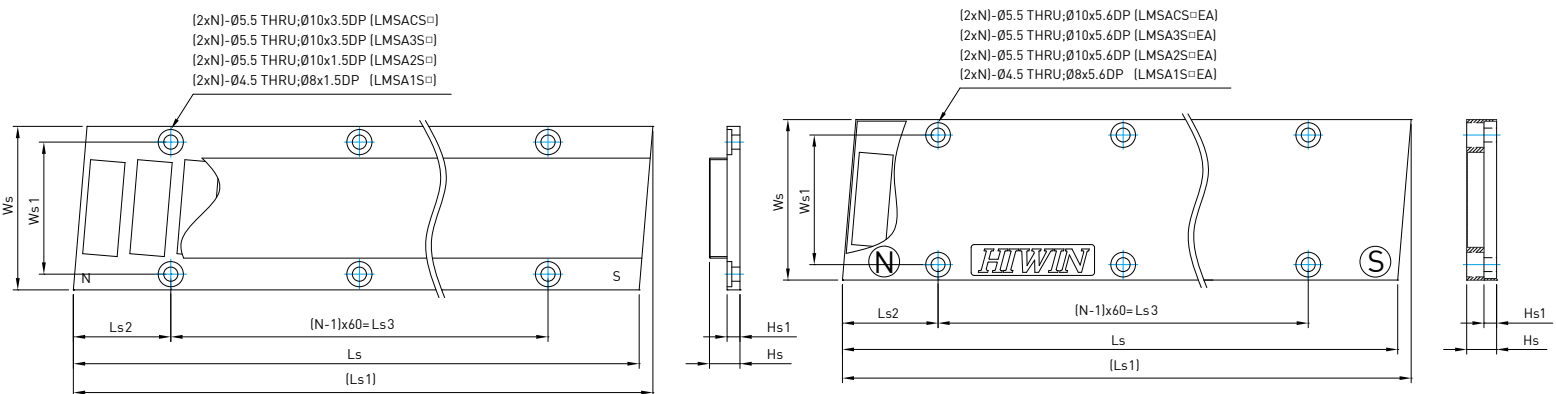

Type	Ls	Ls1	Ls2	Ls3	Ws	Ws1	Hs	Hs1	N
LMSA1S1(EA)	120	124.36	31	60	52	42	9.7	4.1	2
LMSA1S2(EA)	180	184.36	31	120	52	42	9.7	4.1	3
LMSA1S3(EA)	300	304.36	31	240	52	42	9.7	4.1	5
LMSA2S1(EA)	120	122.7	30.57	60	86	74	9.7	4.1	2
LMSA2S2(EA)	180	182.7	30.57	120	86	74	9.7	4.1	3
LMSA2S3(EA)	300	302.7	30.57	240	86	74	9.7	4.1	5
LMSA3S1(EA)	120	123.04	30.37	60	116	104	11.7	6.1	2
LMSA3S2(EA)	180	183.04	30.37	120	116	104	11.7	6.1	3
LMSA3S3(EA)	300	303.04	30.37	240	116	104	11.7	6.1	5
LMSACS1(EA)	120	123.3	30.37	60	126	114	11.7	6.1	2
LMSACS2(EA)	180	183.3	30.37	120	126	114	11.7	6.1	3
LMSACS3(EA)	300	303.3	30.37	240	126	114	11.7	6.1	5

F-V Curve

■ DC bus voltage = 325 V_{DC}

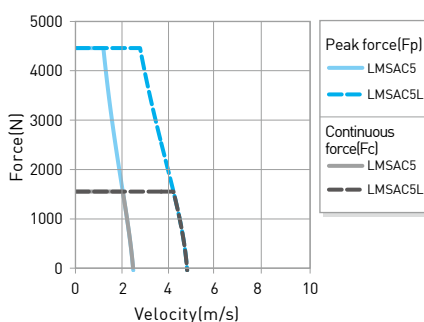
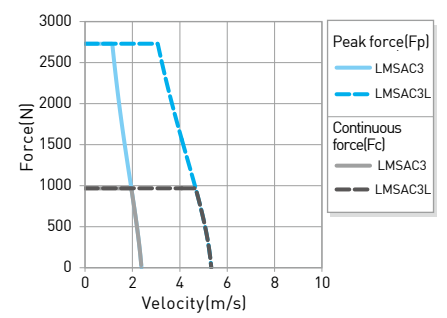
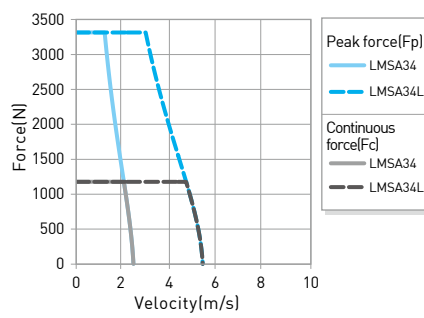
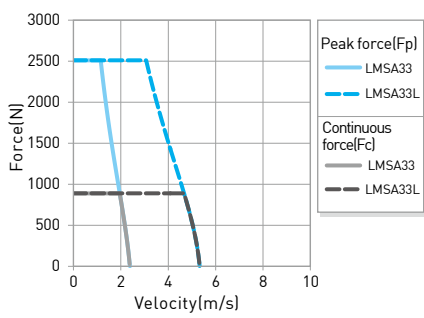
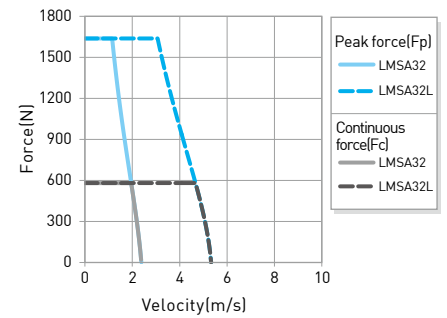
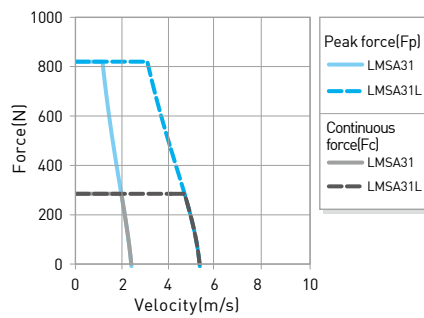
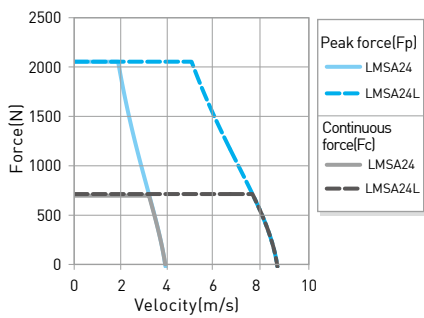
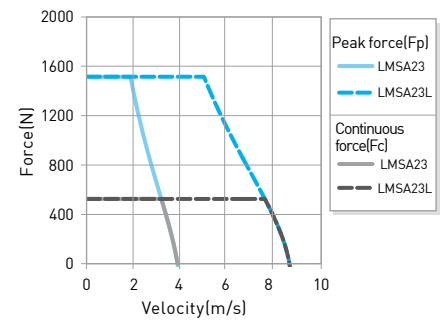
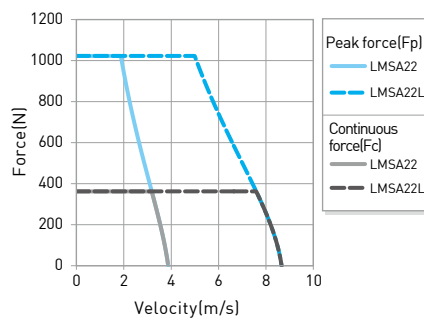
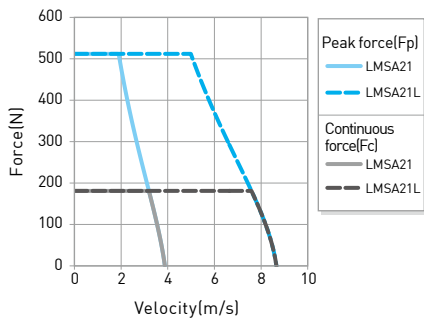
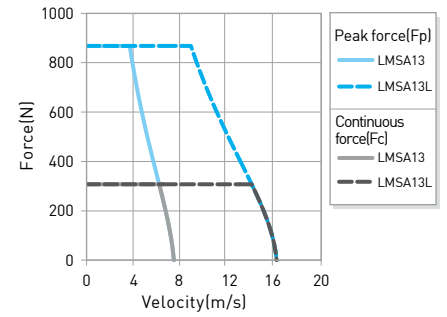
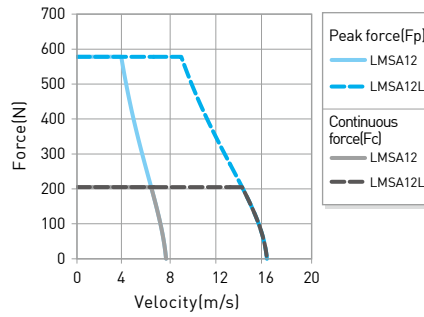
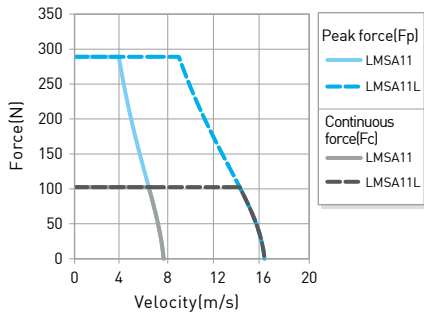

■ DC bus voltage = 600 V_{DC}

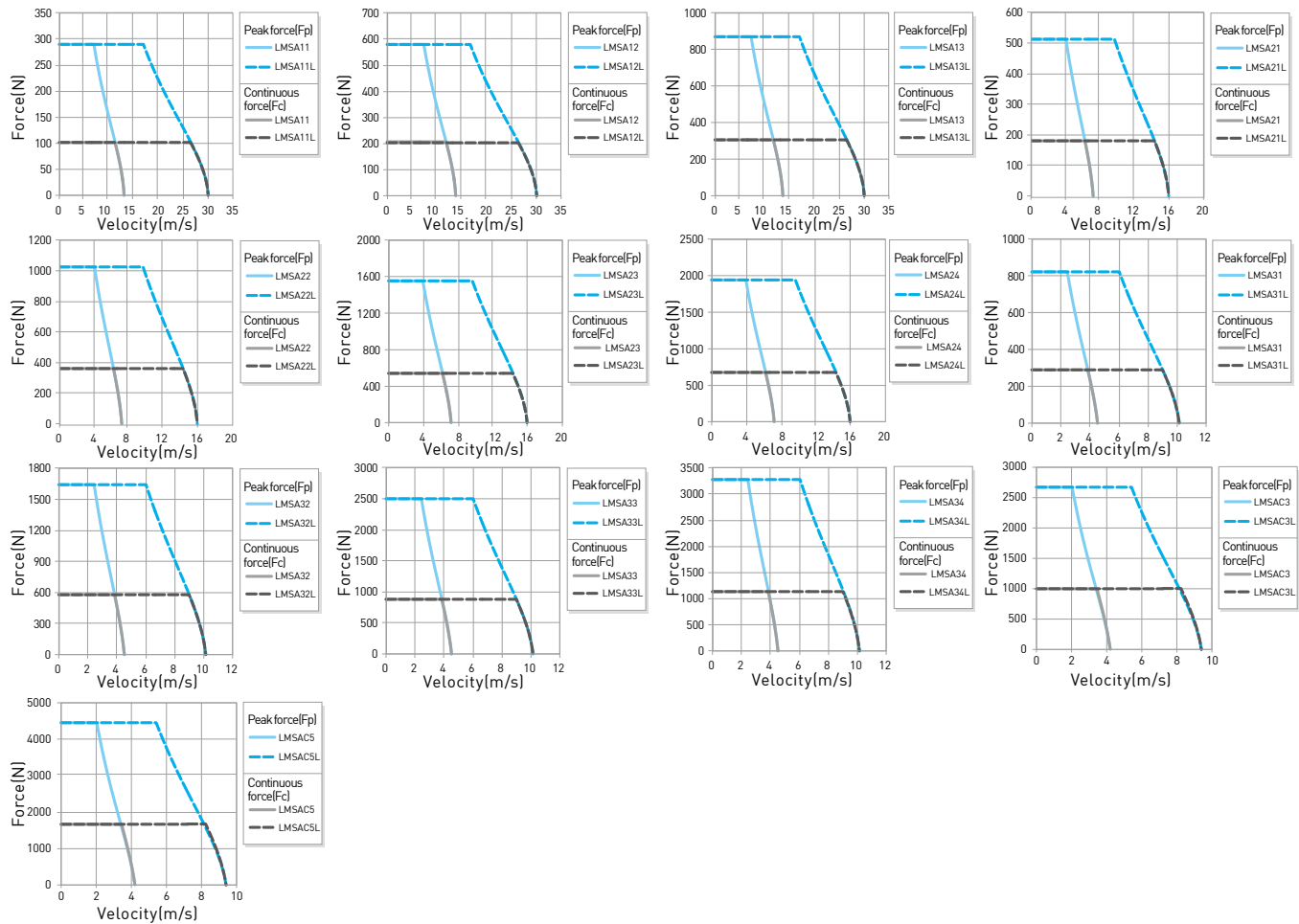

*The specifications in this catalog are subject to change without notification.



Motion Control and System Technology

HIWIN MIKROSYSTEM CORP.

No.6, Jingke Central Rd.,
Taichung Precision Machinery Park,
Taichung 40852, Taiwan
Tel: +886-4-23550110
Fax: +886-4-23550123
www.hiwinmikro.tw
business@hiwinmikro.tw

Subsidiaries & R&D Centers

HIWIN GmbH

OFFENBURG, GERMANY
www.hiwin.de
www.hiwin.eu
info@hiwin.de

HIWIN JAPAN

KOBE · TOKYO · NAGOYA · NAGANO ·
TOHOKU · HOKURIKU · HIROSHIMA ·
KUMAMOTO · FUKUOKA, JAPAN
www.hiwin.co.jp
info@hiwin.co.jp

HIWIN USA

CHICAGO · SILICON VALLEY, U.S.A.
www.hiwin.com
info@hiwin.com

HIWIN S.r.l

BRUGHERIO, ITALY
www.hiwin.it
info@hiwin.it

HIWIN Schweiz GmbH

JONA, SWITZERLAND
www.hiwin.ch
info@hiwin.ch

HIWIN s.r.o.

BRNO, CZECH REPUBLIC
www.hiwin.cz
info@hiwin.cz

HIWIN SINGAPORE

SINGAPORE
www.hiwin.sg
info@hiwin.sg

HIWIN KOREA

SOWON, KOREA
www.hiwin.kr
info@hiwin.kr

HIWIN CHINA

SUZHOU, CHINA
www.hiwin.cn
info@hiwin.cn

Mega-Fabs Motion System, Ltd.

HAIFA, ISRAEL
www.mega-fabs.com
info@mega-fabs.com